



Main characteristics

- Optimized mechanical structure
- Strokes from 50 to 2500 mm
- Wide range of connectors for the electrical connection
- Rod, nipple, exagonal flange AISI 316
- Work temperature: -30°...+75°C
- Resistance to vibrations (DIN IEC68T2/6 12g)
- Power supply 24Vdc ± 20%
- Protection IP67
- Electromagnetic compatibility EMC 2014/30/EU
- Compliant to the directive RoHS 2011/65/EU

Contactless linear position transducer with HYPERWAVE magnetostriuctive technology.

The analog interface, available with various output ranges in voltage or in current, guarantees simpler installation and easier adaptation to existing systems.

The absence of electrical contact on the cursor eliminates all wear and

guarantees almost unlimited life.

High accuracy of the measurement with reference to the non linearity, repeatability and hysteresis. High resistance to vibrations, mechanical shocks for use in a harsh industrial environment.

TECHNICAL DATA

Model	from 50 to 2500 mm
Measurements	displacement
Position read sampling time (typical)	From 0,5 ms to 3 ms (depending on stroke)
Shock test DIN IEC68T2-27	100g - 11ms - single shock
Vibration DIN IEC68T2-6	12g / 10...2000Hz
Displacement speed	≤ 10 m/s
Max. acceleration	≤ 100 m/s ² displacement
Resolution	16 bit (max noise 5 mVpp)
Cursor	Floating separate cursor
Working temperature	-30...+75°C
Storage temperature	-40...+100°C
Coefficient of temperature	≤ 0,01% F.S./°C
Protection	IP67
Operative pressure	350 bar (peak max. 500 bar)

ELECTRICAL DATA

Output signal	0...10V (A)	4...20mA (E) 0...20mA (G)
Nominal power supply	24 Vdc ±20%	24 Vdc ±20%
Max. power ripple	1Vpp	1Vpp
Max. consumption	70mA	90mA
Load on output	5kΩ	< 500Ω
Max. output noise	< 5mVpp	< 5mVpp
Max. output value	12V	30mA
Alarm output value	10.5V	21mA
Electrical isolation	500V (*)	500V (*)
Protection against polarity inversion	Yes	Yes
Protection against overvoltage	Yes	Yes
Protection against power supply on output	Yes	Yes

(*) Using voltage suppressor 30V 0,4J

ELECTRICAL / MECHANICAL DATA

Model		50	100	130	150	200	400	450	500	600	700	750	800	900	1250	1500	1750	2000	2250	2500		
		225	300				1000															
Sampling time	ms	0,5					1					1,5					2					
Dimensions Max. (A)	mm	Model +178,2													Model +183,2							
Electrical stroke	mm	Model																				
Independent linearity		≤ ± 0,02% FS (min ± 0,060 mm)																				
Repeatability	mm	< 0,01																				
Hysteresis	mm	< 0,01																				

MECHANICAL DIMENSIONS

Strokes from 50 to 1000 mm

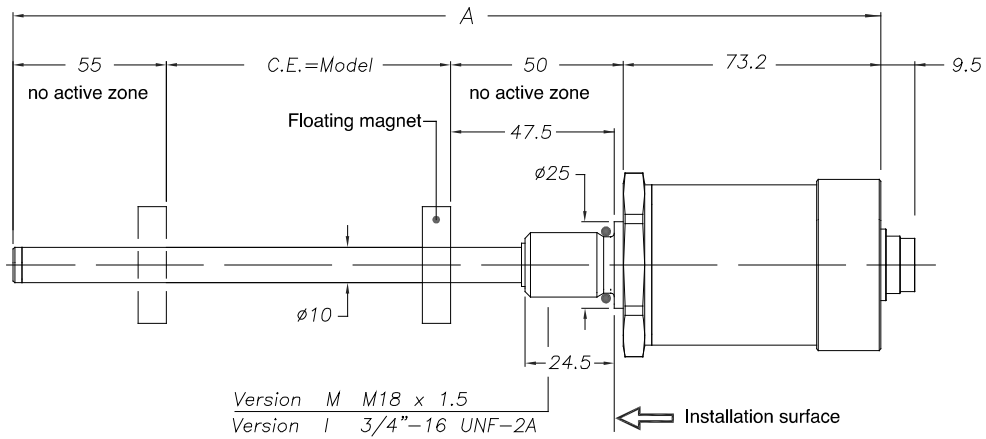

Strokes from 1100 to 2500 mm

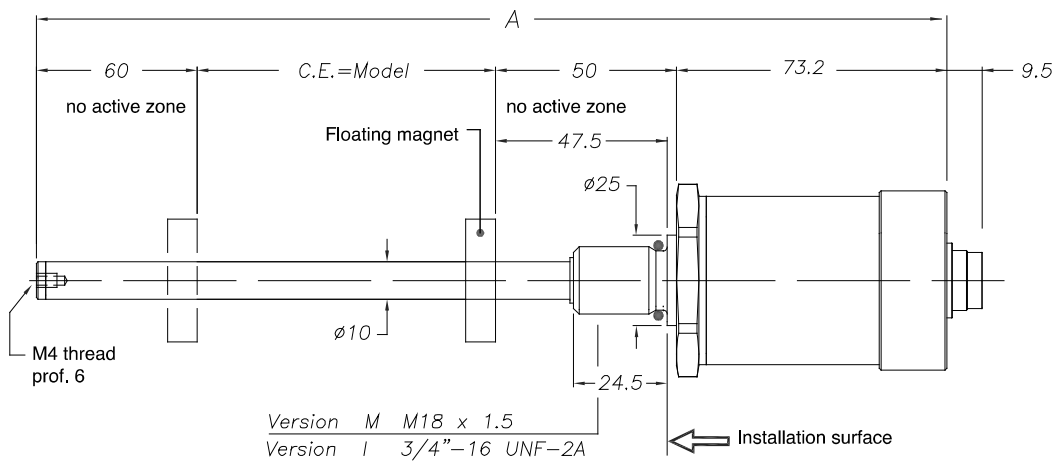

WRP-A-F/R cable output

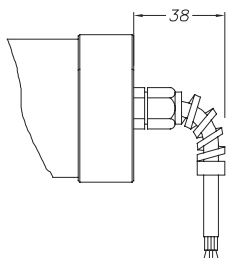

WRP-A-A/B/C/H connector output

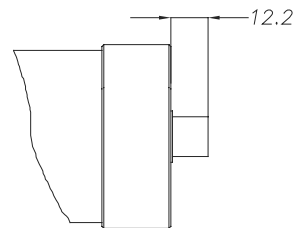

MOUNTING INSIDE A CYLINDER

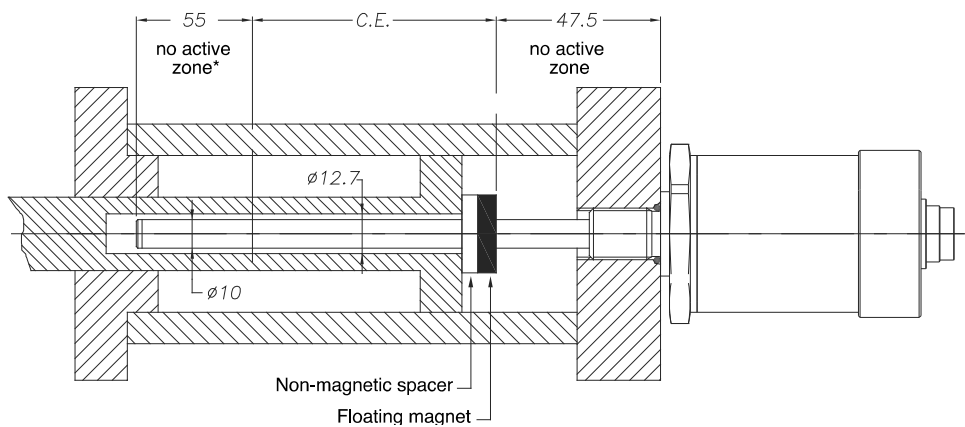

* for stroke up to 1000 mm (included) – over 1000 mm, the non-active zone becomes 60 mm because the tip includes a M4 threaded hole

INSTALLATION INSIDE A CYLINDER

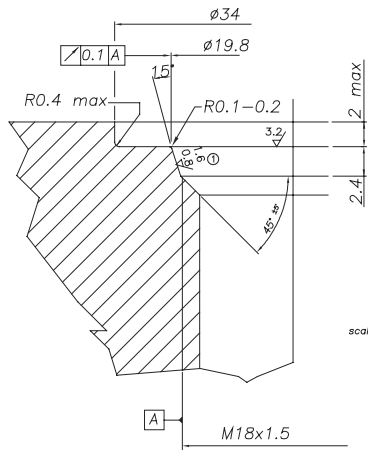

- ① **THREAD M18x1,5**
 The sealing surface must be free from scratches longitudinal or spiral
 Ro 1.6 μm for sealing with NON-pulsating pressure
 Ro 0.8 μm for seals with pulsating pressure

Suggested o-ring:
 PARKER 6-349 15,4x2,1
 Material: Viton 90° Shore-A
 Mixes: PARKER N552-90

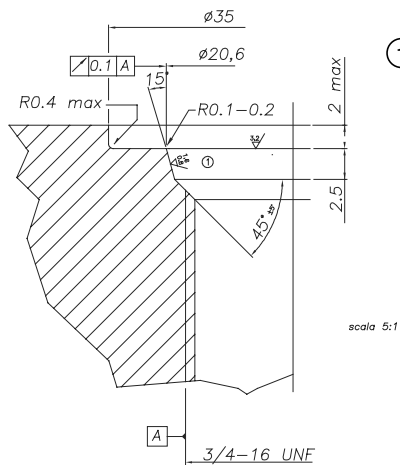
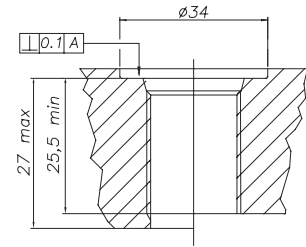

- ① **THREAD 3/4"-16UNF**
 The sealing surface must be free from scratches longitudinal or spiral
 Ro 1.6 μm for sealing with NON-pulsating pressure
 Ro 0.8 μm for seals with pulsating pressure

Suggested o-ring:
 PARKER 3-908 16,36x2,1
 Material: Viton 90° Shore-A
 Mixes: PARKER N552-90

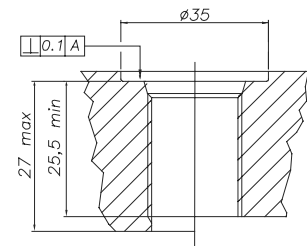

ELECTRICAL CONNECTIONS

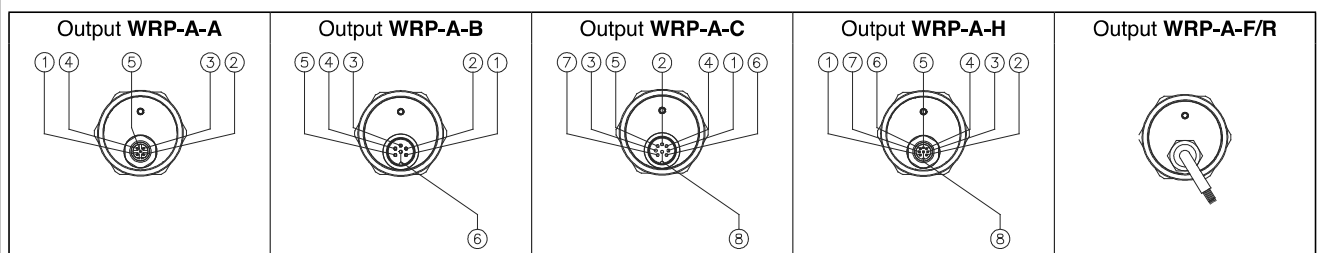

Function	CONNECTORS				CABLES	OPTIONAL CABLES	
	WRP-A-A	WRP-A-B	WRP-A-C	WRP-A-H	WRP-A-F/R	CAV00_	CAV01_/CAV02_
	5 pin M12	6 pin M16	8 pin M16	8 pin M12	Standard cables	Pre-assembled cable 8 pin WRP-A-H	Pre-assembled cable 5 pin WRP-A-A
Output 1 (position) 0...10V 4...20mA 0...20mA	1	1	5 (1*)	5	Grey	Green	Brown
GND Output 1 (0V)	2	2	2	1	Pink	Yellow	White
Output 2 (inverse position) 10...0V 20...4mA 20...0mA	3	3	3	3	Yellow	Pink	Blue
GND Output 2 (0V)	2	4	6	2	Green	Grey	White
Power supply +	5	5	7	7	Brown	Brown	Grey
Power supply GND	4	6	8	6	White	Blue	Black
n.c.	-	-	4	4	-	Red	-
n.c.	-	-	1 (*5)	8	-	White	-

(*) = per versione 4...20mA / 0...20mA

GROUNDING WRP-A

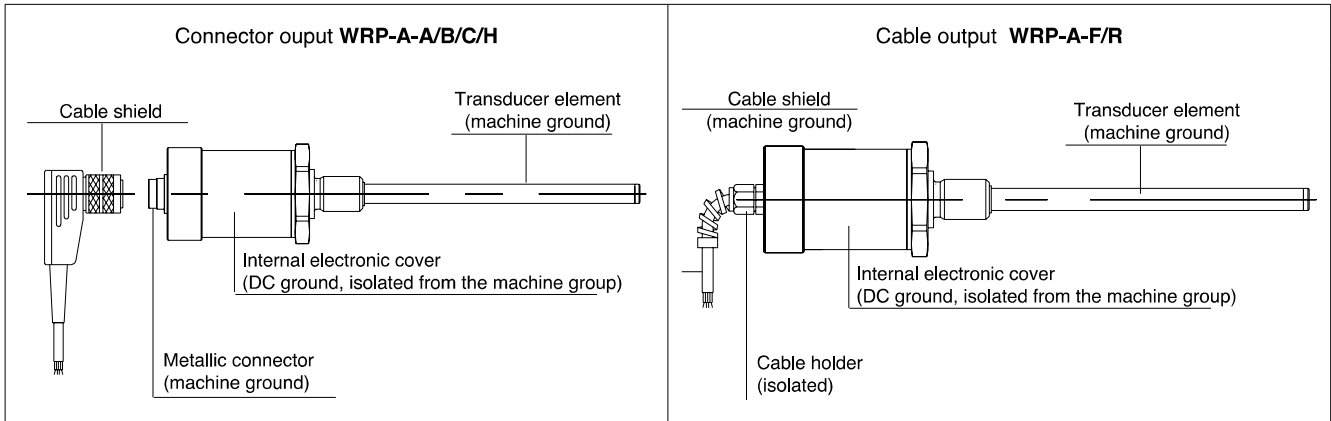

ANALOG OUTPUT

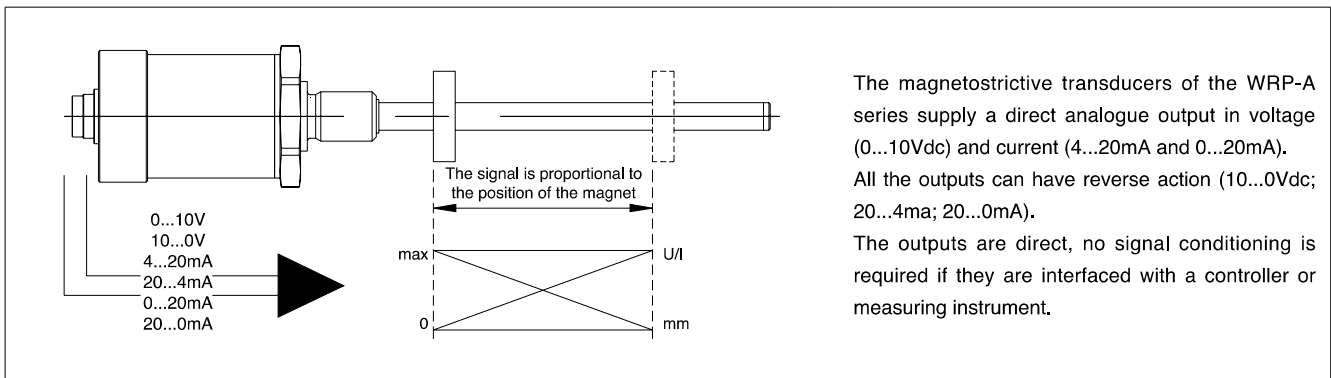

ORDER CODE

Position transducer **W R P A** **1** **0 0 0 0 X X X X S** **0 X X**

Output Connector

M12 5 pin output connector	A
6 pin DIN 45322 output connector	B
8 pin DIN 45326 output connector	C
M12 8 pin output connector	H
PVC output cable	F
PUR output cable high flexibility	R

MODEL

Output

0...10, 10...0 Vcc	A
4...20, 20...4 mA	E
0...20, 20...0 mA	G

Cable lengths

Output F/R 1 mt	00
2 mt	02
3 mt	03
4 mt	04
5 mt	05
10 mt	10
15 mt	15
Output A/B/C/H	00

Thread

M 18x1.5 (standard)	M
3/4" - 16UNF	I

► **Included in the supply**

- Series WR position transducer
- OR 15,4 x 2,1 thread M18 x 1,5 cod: **GUA064**
- OR 16,36 x 2,21 thread 3/4" -16 UNF cod: **GUA065**

► **Magnetic cursors must be ordered separately**

Mechanical and/or electrical characteristics differing from those in the standard version may be arranged on request.

Ex.: **WRP-A-B-0400-A-1 0000XXXXS00M0XX**
 Transducer model WRP-A, analog output, B connector, model 400mm, 0...10Vdc output, thread M18x1,5

FLOATING CURSOR



Cursors	
Cursor Diameter 32.8	095
Cursor Diameter 32.8 with 90° slit	096
Cursor Diameter 25.4	097
Floating cursor for liquids with hole diameter 12	098

The **PCUR095** is supplied with:
 N° 8 Brass nuts M4
 N° 8 Brass washers D4
 N° 4 Brass screws M4x25

The **PCUR096** is supplied with:
 N° 4 Brass nuts M4
 N° 4 Brass washers D4
 N° 2 Brass screws M4x25

Dimensions	A	B	C	D	Thickness
PCUR095	32.8	13.5	23.9	-	7.9
PCUR096				11	
PCUR097	25.4	13.5		-	

Model		PCUR098
Length A	mm	52.4
Diameter B (hole)	mm	12
Diameter C	mm	44
Material		AISI 316

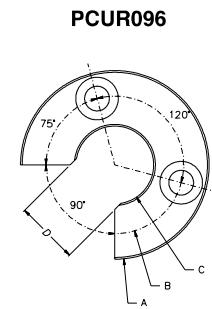
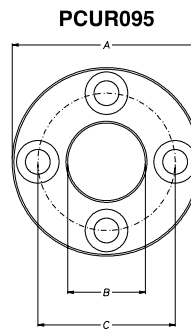

PCUR097

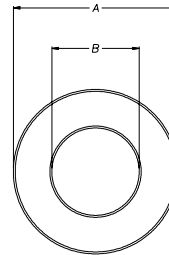

HEIGHT DETECTION POSITION

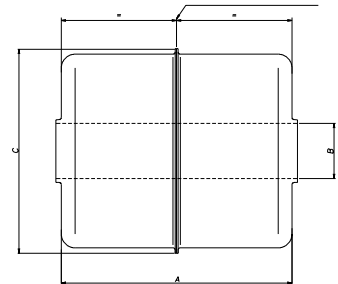

Note: PCUR098 is supplied with kit PKIT036 for floating cursor for liquids.

OPTIONAL CONNECTORS

For **WRP-A-A** and **WRP-A-H**, M12 thread connector

CON031 and CON041 for 5 pin output (WRP-A-A)
 CON035 and CON042 for 8 pin output (WRP-A-H)

For **WRP-A-B** and **WRP-A-C**, M16 thread connector

CON021, CON022 and CON023 for 6 pin output (WRP-A-B)
 CON026, CON027 and CON028 for 8 pin output (WRP-A-C)

Connector extraction length 10mm

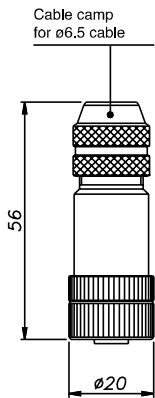

CON031
CON035
IP67 - IEC 48B

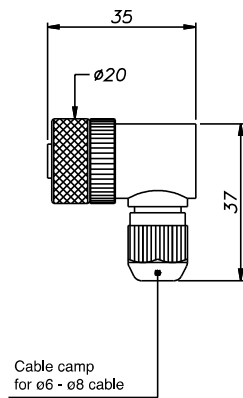

CON041
CON042
IP67

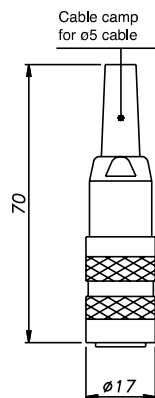

CON021
CON026
IP40 - EMC

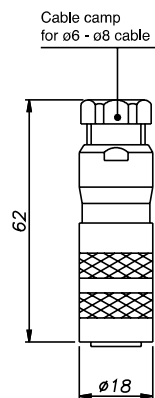

CON022
CON027
IP67 - EMC

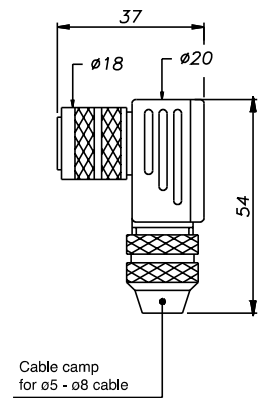

CON023
CON028
IP67 - EMC

1. The IP rating specified in this document normally applies with the suitable female connector plugged-in and properly wired.

OPTIONAL OUTPUT CABLES

For **WRP-A-A**, cable with connector (straight or 90°) with M12 thread 5 pin

5-pin cable code		WRP-A-A	
Lenght "L"		CODE	
		Straight cable	Cable to 90°
2	mt	CAV011	CAV021
5	mt	CAV012	CAV022
10	mt	CAV013	CAV023
15	mt	CAV015	CAV024

For **WRP-A-A**, cable with connector (straight or 90°) with M12 thread 8 pin

8-pin cable code		WRP-A-H	
Lenght "L"		CODE	
		Straight cable	Cable to 90°
2	mt	CAV002	CAV005
5	mt	CAV003	CAV006
10	mt	CAV004	CAV007
15	mt	CAV009	CAV008

ACCESSORIES

Non-magnetic spacer for mounting PCUR022 cursor

CUR022

Electrical installation requirements and Conformity certificate are available on our web site: www.gefran.com

GEFRAN spa reserved the right to make aesthetic or functional changes at any time and without notice.